

## Anti Static Capacitive Bar with air knife, working distance up to 2000 mm

# ECOFLOW

### Static Neutralizing Bar with air knife ECOFLOW

The combination of an anti-static bar and an air knife creates a curtain of ionized air. By its power and high ionic concentration this ionized air curtain neutralizes electrostatic charges and expels parasite particles.

The air knife uses the COANDA effect to draw large laminar flows at high speed with a very small volume of compressed air. The amplification coefficients are 25:1. This has the effect of reducing compressed air consumption by 40 % and the noise level by 10 dB, when compared with a tradition blower system (perforated pipe, nozzle, etc.). An ECA 88B anti-static electrode is installed on this knife, freeing positive and negative ions carried by the air flow to a distance of up to 2 meters.

The exceptional performance of the ECOFLOW enables productivity to be increased and finished product quality to be improved, while raising the level of safety and comfort for machine operators. The ECOFLOW participates actively in Elimination: dust, foreign matter, attraction and sticking phenomena, electrostatic charges and breakdown phenomena and Cooling: of molded and injected parts.

#### Concerned industries:

- Plastics: extrusion, injection, machining, pressing, molding and coiling.
- Glass: rolling and screen printing.
- Textile: carding, flame treatment and coiling.
- Agro food/pharmaceutical: packing and packaging.
- Automobile: dust removal before painting or assembly.
- Paper: treatment before printing.

- Efficient
- Strong
- Proven reliability
- Standard version under an aluminum rail, (optional stainless steel)
- Shockless safety ionization tips
- Fast delivery



# Anti Static Capacitive Bar with air knife ECOFLOW

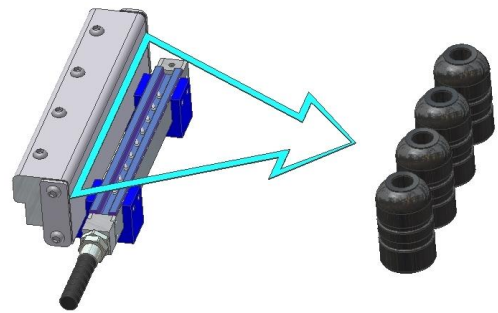

## TECHNICAL DATA

Working distance: 2000 mm max.

Dimensions: 110 x 70 x 58 mm

Characteristics: ECA88-B ionizing bar, supplied as standard with 3 meters of cable (No7 + connector), 1/4" NPT compressed air connection, range: at 2 bars of pressure = 0.5m at 4 bars of pressure = 1m

Recommended generator: SC 04 B, do not exceed 10 meters of HT No 7 sheathed cable per generator.

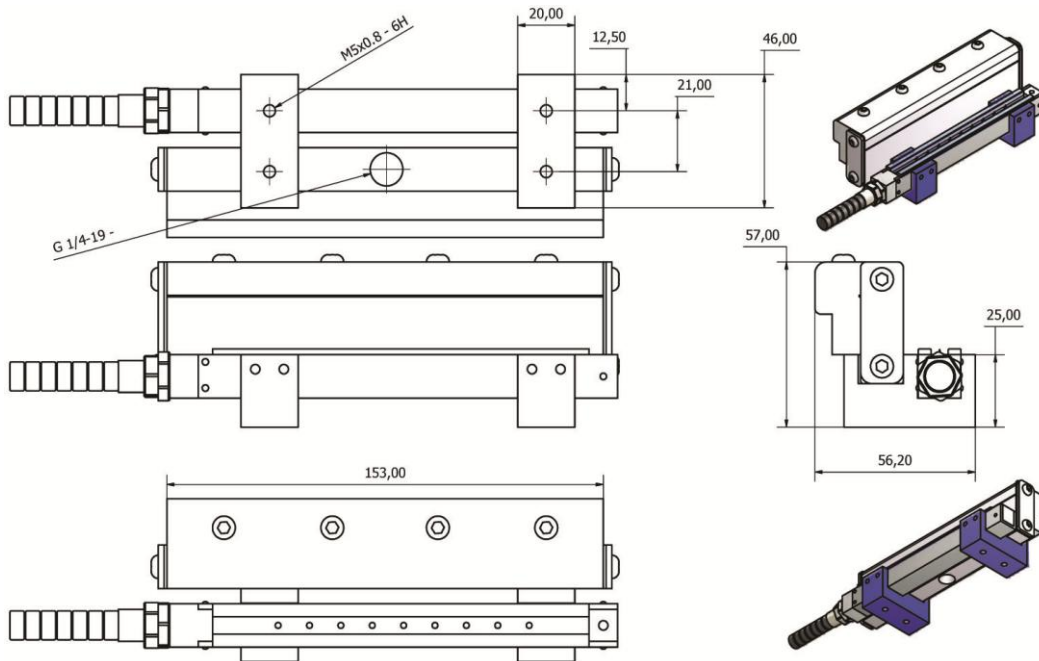

Alim.	Consommation/débit				Caractéristiques du flux d'air à différentes distances en mm de la sortie de l'appareil							
	ECOFLOW 150	ECOFLOW 300	ECOFLOW 450	ECOFLOW 600	150	300	600	900	1200	1800		
0,70	C	221	441	662	883	V	251	175	122	69	53	30
	D	5519	11037	16556	22074	W	64	127	114	89	127	152
1,40	C	272	543	815	1087	V	381	335	244	160	122	61
	D	6792	13584	20376	27168	W	51	102	133	121	165	178
2,00	C	357	713	1070	1426	V	533	503	366	244	213	152
	D	8915	17829	26744	35658	W	57	108	140	133	152	203
2,80	C	425	849	1274	1698	V	777	655	495	351	305	213
	D	10613	21225	31838	42450	W	64	121	165	178	178	203
4,10	C	594	1189	1783	2377	V	1402	975	823	671	549	335
	D	14858	29715	44573	59430	W	70	133	241	260	229	241
5,50	C	730	1460	2190	2921	V	1935	1387	1189	975	792	442
	D	18254	36507	54761	73014	W	70	140	267	318	368	508
7,00	C	934	1868	2802	3736	V	2377	1722	1463	1219	991	549
	D	23348	46695	70043	93390	W	76	146	279	381	406	508





C = Consommation en l/mn

V = Vitesse de pointe en m/mn

**This equipment must not be used in an inflammable or explosive environment!**

The air knife and the power unit are to be earthed well so that the appliance operates properly

It is essential to use air containing no trace of oil or humidity, filtration 5µm / do not use quick-release connectors on the compressed air supply

 ELCOWA s.a. 27 Rue de Ruelisheim F-68200 MULHOUSE  
 +33 (0) 389 573 573  
 @sales@elcowa.com  
 +33 (0) 389 571 718  
 www.elcowa.com

